

# Data Sheet



Article number: 021816011265

Description: Clamp with bracket and rubber  
SPGU 6011. 265/30 SK

## Measures

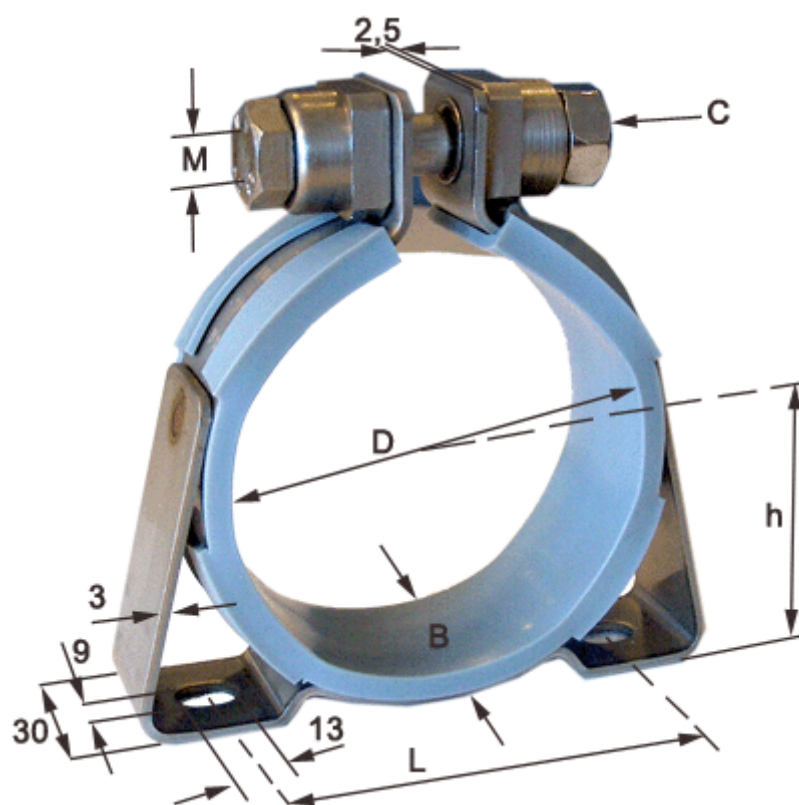

C (screw type) = SK hexagon screw

Diameter D = 265

h = 141

L = 248

Width B = 30